

# 19.5-40 Watt Hybrid

## Features

- Rad Hard: TID > 100kRad(Si)
- 2:1 margin: Operates beyond 200kRad TID
- No SEE: LET > 82MeV\*cm<sup>2</sup>/mg
- Proton Resistant: No optocouplers used
- Specifically engineered for 70 VDC satellite bus
- Completely self contained Thick Film Hybrid DC-DC Converter
- No external filter caps required
- Fully isolated design
- "Inhibit-not" function
- Power on soft start
- 200 kHz operation for low ripple and fast response time
- Built-in EMI input filter meets MIL-STD-461C requirements CE01, CE03, CS01, CS02 and CS06
- Short circuit and overvoltage protection
- Capability of external sync for switching frequencies
- Built-in test capability

## Specifications

**INPUT:** 70 VDC nominal

Range: 55 to 90 VDC continuous

### ISOLATION:

Input to case: 500 VDC

Input to output: 500 VDC

Output to case: 100 VDC

### ENVIRONMENT:

Storage temperature: -55°C to +150°C

Shock: 50 G's

Acceleration: 500 G's

Vibration: 30 G's

Grades EU, L, R & S:

Full Power Output at T<sub>case</sub> = +85°C

Linearly derates to zero at T<sub>case</sub> = +115°C

Grades LE, RE & SE:

Full Power Output at T<sub>case</sub> = +125°C

Linearly derates to zero at T<sub>case</sub> = +135°C

Grades L & LE:

TID up to 45kRad(Si)

No SEE up to 60MeV\*cm<sup>2</sup>/mg

**WEIGHT:** 90 grams typical

SINGLE OUTPUT DEVICES		8193-S03.3 (26.4W)			8193-S05 (40W)			8193-S05.2 (40W)			8193-S12 (40W)		
PARAMETER	CONDITION	MIN	TYP	MAX	MIN	TYP	MAX	MIN	TYP	MAX	MIN	TYP	MAX
Output voltage	—	+3.2	+3.3	+3.4	+4.9	+5.0	+5.1	+5.1	+5.2	+5.3	+11.9	+12.0	+12.1
Output current	V <sub>in min</sub> — V <sub>in max</sub>	—	—	8A	—	—	8A	—	—	7.69A	—	—	3.33A
Efficiency	P <sub>out</sub> = max rated load	66%	69%	—	71%	74%	—	71%	74%	—	78%	82%	—
Line regulation	P <sub>out</sub> = max rated load V <sub>in min</sub> — V <sub>in max</sub>	—	10mV	30mV	—	10mV	50mV	—	10mV	50mV	—	20mV	100mV
Load regulation	P <sub>out</sub> = 10% to F.L.	—	10mV	30mV	—	10mV	50mV	—	10mV	50mV	—	20mV	100mV
Output ripple	F.L. BW 2 MHz mV <sub>pp</sub>	—	30	65	—	40	85	—	40	85	—	60	150

SINGLE OUTPUT DEVICES		8193-S15 (40W)			8193-S28 (40W)								
PARAMETER	CONDITION	MIN	TYP	MAX	MIN	TYP	MAX						
Output voltage	—	+14.9	+15.0	+15.1	+27.8	+28.0	+28.2						
Output current	V <sub>in min</sub> — V <sub>in max</sub>	—	—	2.67A	—	—	1.43A						
Efficiency	P <sub>out</sub> = max rated load	79%	83%	—	78%	82%	—						
Line regulation	P <sub>out</sub> = max rated load V <sub>in min</sub> — V <sub>in max</sub>	—	25mV	125mV	—	50mV	250mV						
Load regulation	P <sub>out</sub> = 10% to F.L.	—	25mV	125mV	—	50mV	250mV						
Output ripple	F.L. BW 2 MHz mV <sub>pp</sub>	—	75	180	—	150	350						

Model No.	Case Style	Pin Count	Mounting
8193	2	12	Solder Sealed Flangeless PCB Mount
8193	F	12	Solder Sealed PCB Mount with Flange
8193	J	12	Seam Weld Flangeless PCB Mount
8193	JF	12	Seam Weld PCB Mount with Flange
8193	XF	8	Seam Weld Chassis Mount with Flange
8193	PC	10	Solder Sealed Flangeless PCB Stud Mount

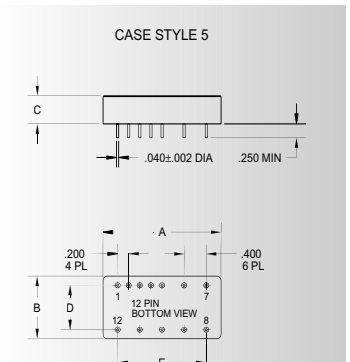
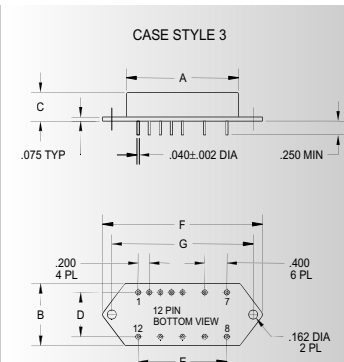
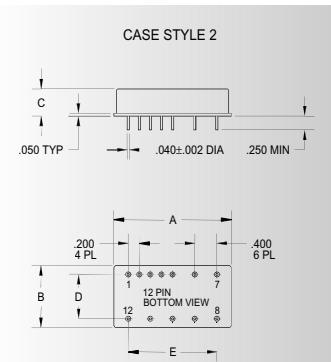

**TOLERANCES:** ALL DIMENSIONS ±0.01 EXCEPT F = MAX, C = +0.01/-0.02; DRAWINGS IN INCHES.

## Case Dimensions

Units: inches | millimeters

Case Style	A	B	C	D	E	F	G
2	2.205   56.007	1.755   44.577	0.495   12.573	1.400   35.560	1.600   40.640	—   —	—   —
3 F	2.205   56.007	1.755   44.577	0.495   12.573	1.400   35.560	1.600   40.640	2.960   75.184	2.610   66.294
5 J	2.205   56.007	1.755   44.577	0.495   12.573	1.400   35.560	1.600   40.640	—   —	—   —
6 JF	2.220   56.388	1.760   44.704	0.495   12.573	1.400   35.560	1.600   40.640	2.960   75.184	2.610   66.294
8 XF	2.220   56.388	2.110   53.594	0.495   12.573	—   —	1.600   40.640	2.960   75.184	2.610   66.294
10 PC	2.220   56.388	1.760   44.704	0.495   12.573	1.400   35.560	1.600   40.640	—   —	—   —

# DC-DC CONVERTERS

## PROTON RAD HARD 100K+™ SERIES

# 8193

### MAGNETICALLY ISOLATED

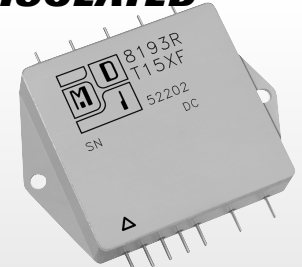

### 70 VDC

DUAL OUTPUT DEVICES		8193-D05 (40W)			8193-D12 (40W)			8193-D15 (40W)		
PARAMETER	CONDITION	MIN	TYP	MAX	MIN	TYP	MAX	MIN	TYP	MAX
Output voltage	$+I_{out} = -I_{out}$	+4.9	+5.0	+5.1	+11.9	+12.0	+12.1	+14.9	+15.0	+15.1
		-4.9	-5.0	-5.1	-11.9	-12.0	-12.1	-14.9	-15.0	-15.1
Output current*	$V_{in\ min} - V_{in\ max}$	±150mA	—	±4A	±95mA	—	±1.67A	±76mA	—	±1.33A
Efficiency	$P_{out} = \text{max rated load}$	73%	76%	—	78%	82%	—	79%	83%	—
Line regulation	$P_{out} = \text{max rated load}$ $V_{in\ min} - V_{in\ max}$	—	±10mV	±50mV	—	±20mV	±100mV	—	±25mV	±125mV
		—	±10mV	±50mV	—	±20mV	±100mV	—	±25mV	±125mV
Load regulation†	$P_{out} = 10\%$ to F.L.	—	±10mV	±50mV	—	±20mV	±100mV	—	±25mV	±125mV
Output ripple	F.L. BW 2 MHz mV <sub>pp</sub>	—	40	85	—	60	150	—	75	180

Notes: \*Up to 90% full power available from either output if rated output power is not exceeded; †balanced load conditions.

TRIPLE OUTPUT DEVICES		8193-T3.3/5 (17.5W)			8193-T3.3/12 (24W)			8193-T3.3/15 (25.2W)			8193-T05 (19.5W)			8193-T12 (25.8W)			8193-T15 (27W)		
PARAMETER	CONDITION	MIN	TYP	MAX	MIN	TYP	MAX	MIN	TYP	MAX	MIN	TYP	MAX	MIN	TYP	MAX	MIN	TYP	MAX
Output voltage	$+I_{out} = -I_{out}$	+3.2	+3.3	+3.4	+3.2	+3.3	+3.4	+3.2	+3.3	+3.4	+4.9	+5.0	+5.1	+4.9	+5.0	+5.1	+4.9	+5.0	+5.1
		-4.9	-5.0	-5.1	-11.9	-12.0	-12.1	-14.9	-15.0	-15.1	-4.9	-5.0	-5.1	-11.9	-12.0	-12.1	-14.9	-15.0	-15.1
Output current	$V_{in\ min} - V_{in\ max}$	400mA	—	4A	400mA	—	4A	400mA	—	4A	90mA	—	3A	90mA	—	3A	90mA	—	3A
		±40mA	—	±450mA	±40mA	—	±450mA	±32mA	—	±400mA	±40mA	—	±450mA	±40mA	—	±450mA	±32mA	—	±400mA
Efficiency	$P_{out} = \text{max rated load}$	66%	69%	—	66%	69%	—	66%	69%	—	66%	69%	—	71%	74%	—	71%	74%	—
Line regulation	$P_{out} = \text{max rated load}$ $V_{in\ min} - V_{in\ max}$	—	10mV	50mV	—	10mV	50mV	—	10mV	50mV	—	10mV	50mV	—	10mV	50mV	—	10mV	50mV
		—	25mV	50mV	—	25mV	50mV	—	25mV	50mV	—	25mV	50mV	—	25mV	50mV	—	25mV	50mV
Load regulation	$P_{out} = 10\%$ to F.L.	—	10mV	50mV	—	10mV	50mV	—	10mV	50mV	—	10mV	50mV	—	10mV	50mV	—	10mV	50mV
		—	25mV	50mV	—	25mV	50mV	—	25mV	50mV	—	25mV	50mV	—	25mV	50mV	—	25mV	50mV
Output ripple	F.L. BW 2 MHz mV <sub>pp</sub>	—	30	65	—	30	65	—	30	65	—	40	85	—	40	85	—	40	85
		—	—	50	—	—	50	—	—	50	—	—	50	—	—	50	—	—	50

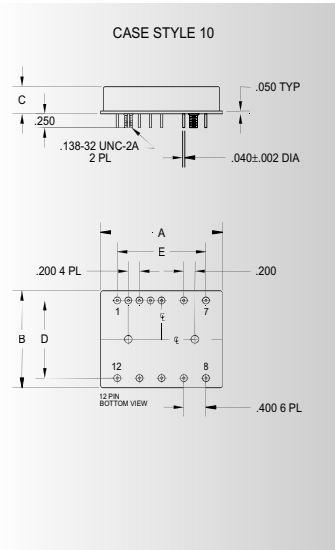
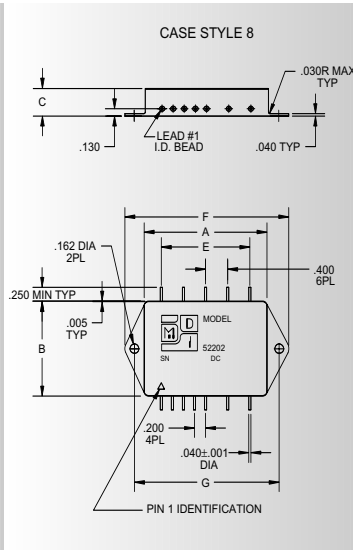
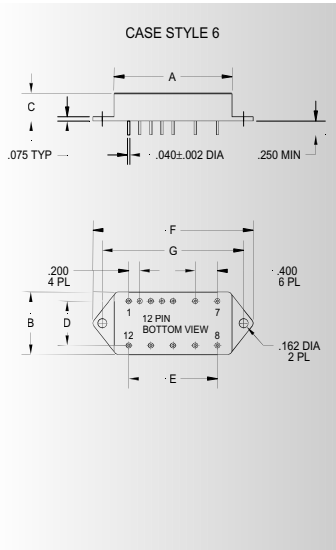

8193-SXX output <24 VDC			8193-SXX output ≥24 VDC			8193-DXX			8193-TXX		
Pin 1	bit	Pin 7 + input	Pin 1	bit	Pin 7 + input	Pin 1	bit	Pin 7 + input	Pin 1	bit	Pin 7 + input
Pin 2	inhibit not	Pin 8 main output	Pin 2	inhibit not	Pin 8 + remote sense	Pin 2	inhibit not	Pin 8 + remote sense	Pin 2	inhibit not	Pin 8 main output
Pin 3	soft start	Pin 9 main output ret	Pin 3	soft start	Pin 9 - remote sense	Pin 3	soft start	Pin 9 - remote sense	Pin 3	soft start	Pin 9 main output ret
Pin 4	sync	Pin 10 + remote sense	Pin 4	sync	Pin 10 main output	Pin 4	sync	Pin 10 + dual output	Pin 4	sync	Pin 10 + dual output
Pin 5	N/C	Pin 11 adjust	Pin 5	adjust	Pin 11 N/C	Pin 5	adjust	Pin 11 dual output ret	Pin 5	N/C	Pin 11 dual output ret
Pin 6	input ret	Pin 12 - remote sense	Pin 6	input ret	Pin 12 main output ret	Pin 6	input ret	Pin 12 - dual output	Pin 6	input ret	Pin 12 - dual output

Please specify **GRADE LEVEL** for your application. EU grade units will be shipped if no option is specified.

**EU** Engineering Units  
**R** 100 K+™, +85°C military/aerospace  
**L** 45 K, +85°C military/aerospace

**RE** 100 K+™, +125°C military/aerospace  
**S** 100 K+™, +85°C space  
**LE** 45 K, 125°C military/aerospace

**SE** 100 K+™, +125°C space